

AC AXIAL FAN Ø500

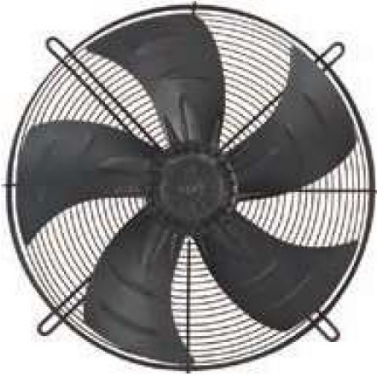

Product Characteristic

Motor technology: AC Outer rotor
 Mode of Operation: S1
 Protection Class: IP54
 Insulation Class: B/F
 Bearings: Maintenance-free ball bearings
 Blades Material: Cold rolled sheet steel
 Blades count: 5
 Air direction: seen on the leads

Flow Rate Curve

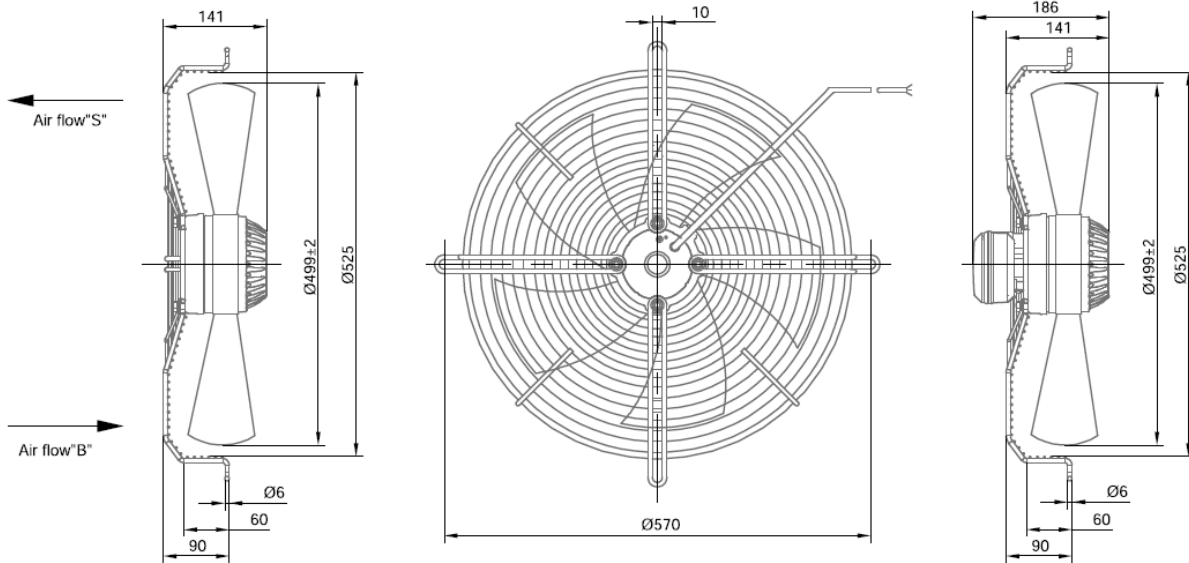
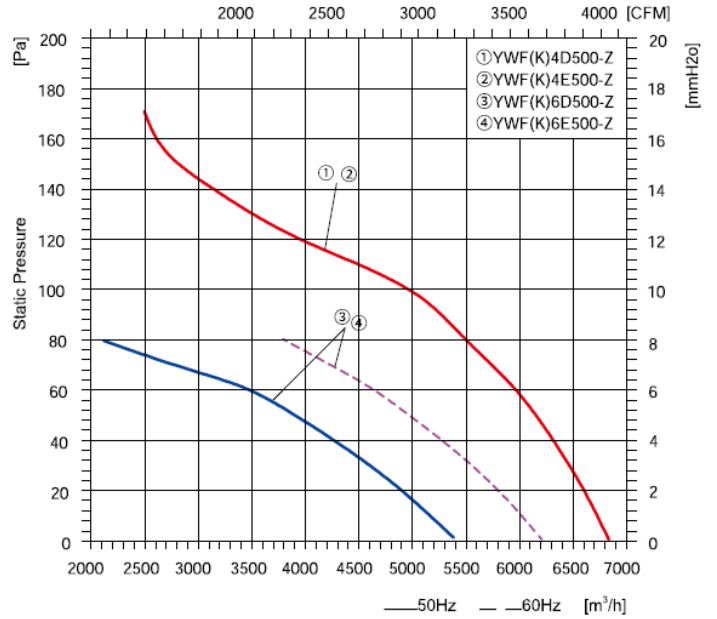

Model	Code	Voltage (V)	Frequency (Hz)	Input Power (W)	Current (A)	Air Volume (m³/h)	Speed (r/min)	Capacitor (µF)	Noise [(dB(A)]	Max Environmental Temperature (°C)	Weight (Kg)
YWF(K)4E500-Z	ZO4E500	230	50	420	1.85	6950	1320	12	72	50	9.5
YWF(K)4D500-Z	ZO4D500	380	50	450	0.93	7000	1320	-	72	50	9.5
YWF(K)6E500-Z	ZO6E500	230	50	230	1.15	5200	920	6	67	60	9.5
YWF(K)6D500-Z	ZO6D500	380	50	250	0.78	5200	920	-	67	60	9.5

Air Flow "B" = Blow "S" = Suck Needs to be specified when ordering