

AC AXIAL FAN Ø350



Product Characteristic

Motor technology: AC Outer rotor
 Mode of Operation: S1
 Protection Class: IP54
 Insulation Class: B/F
 Bearings: Maintenance-free ball bearings
 Blades Material: Cold rolled sheet steel
 Blades count: 5
 Air direction: seen on the leads

Flow Rate Curve

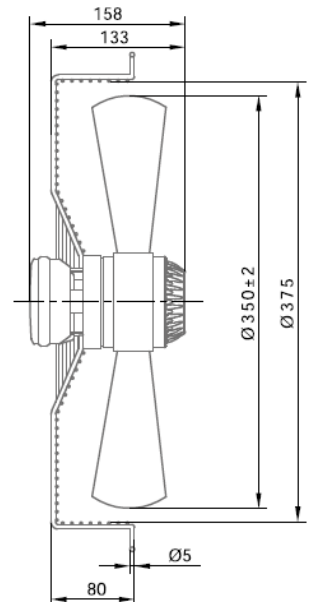
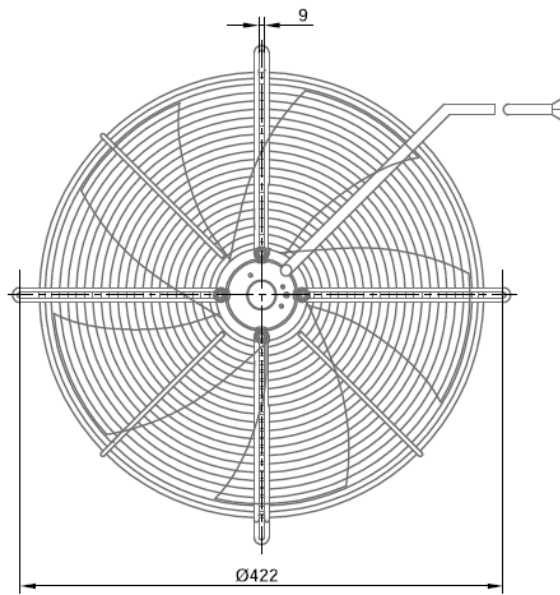
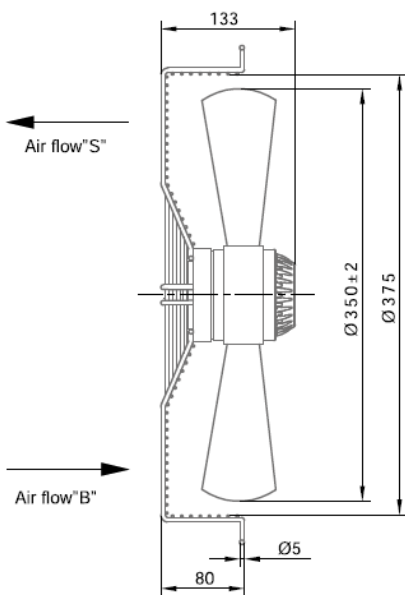
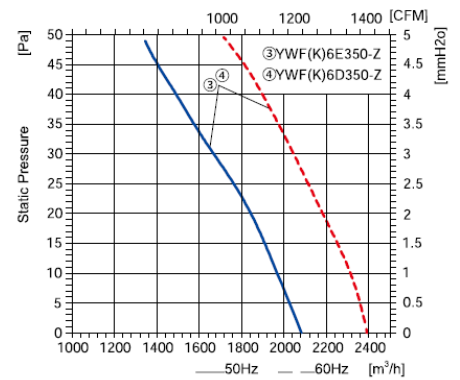
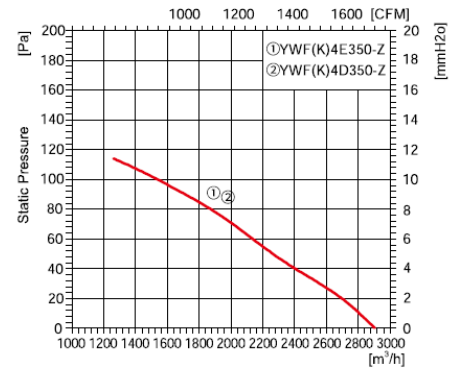

Model	Code	Voltage (V)	Frequency (Hz)	Input Power (W)	Current (A)	Air Volume (m³/h)	Speed (r/min)	Capacitor (µF)	Noise [(dB(A)]	Max Environmental Temperature (°C)	Weight (Kg)
YWF(K)4E350-Z	ZO4E350	230	50	138	0.68	2980	1370	4	62	65	4.7
YWF(K)4D350-Z	ZO4D350	380	50	145	0.37	3000	1390	-	63	65	4.7
YWF(K)6E350-Z	ZO6E350	230	50	80	0.4	2100	930	2	53	65	4.7
YWF(K)6D350-Z	ZO6D350	380	50	90	0.29	2100	940	-	53	65	4.7

Air Flow "B" = Blow "S" = Suck Needs to be specified when ordering